

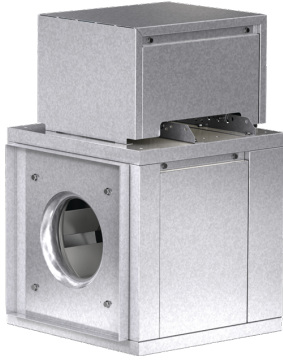

SKU
BSQ-100-5X-3-QD-DR3

Nombre del Proyecto:
Marca:
Enviado por:
Fecha: 11/20/2019

Centrifugal Inline Fan, Model BSQ-100, Belt Drive, 1/2HP, 208-230/460V, 3Ph, Motor & Drives Unassembled, 1174-1703 CFM



Model BSQ centrifugal inline fan features a unique combination of installation flexibility, rugged construction, ease of service, high efficiency and low sound levels. These compact fans are the ideal selection for indoor clean air applications including intake, exhaust, return or make-up air.

- Removable access panels allow easy access to all interior components
- Aluminum, centrifugal wheel delivers maximum efficiency
- Inlet and discharge duct collars allow for easy duct connection
- Rigid, galvanized steel housing construction
- Factory tested bearings designed specifically for air handling applications with a minimum L₁₀ life in excess of 100,000 hours
- Motor, pulleys and belt ship separately for field assembly

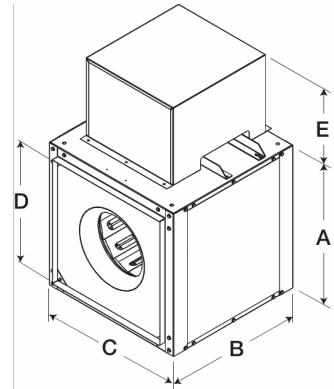

A	B	C	D	E
17 in	21 in	17 in	13.875 in	12.5 in

Certifications

AMCA Sound & Air
UL/cUL 705

Características de funcionamiento

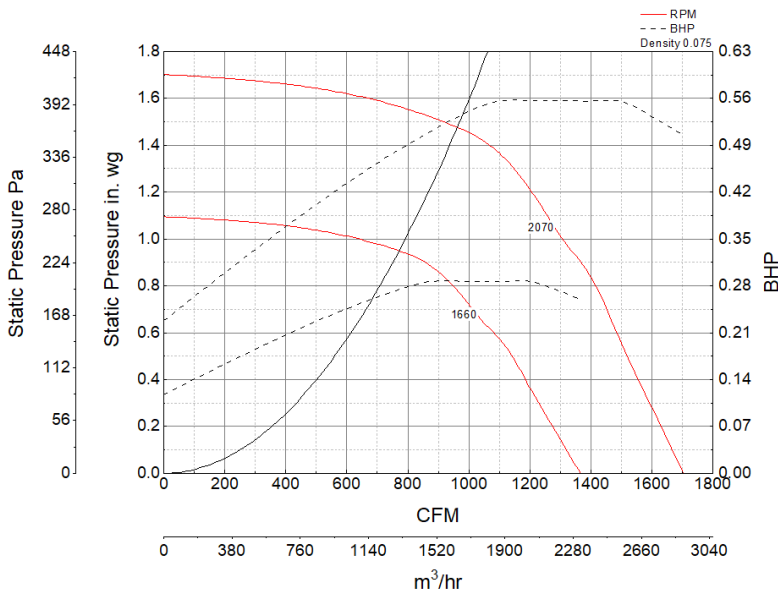

Características de Construcción

Drive Type	Belt Drive
Impeller Type	Centrifugal Wheel
Impeller Material	Aluminum
Housing Material	Galvanized Steel
Includes	Disconnect switch Motor cover Unassembled drive package
Max Inlet Temp	160 °F
Certifications	AMCA Sound & Air UL/cUL 705
Drive Package Description	Motor and drives shipped loose

Información del motor

Service Factor	1.15
Phase	3
Voltage	208 230 460
HP	1/2
Hertz	60
Motor Enclosure	Open Drip Proof
RPM	1800
Motor Insulation	F
Thermal Protection	No
Nominal Efficiency	68

Rendimiento de Aire y Sonido

HP Motor	BHP Max	Max Fan RPM	Min Fan RPM	Ps (in. wg)	0	0.125	0.25	0.375	0.5	0.625	0.75	0.875	1	1.25
1/2	0.56	2070	1660	PCM	1,703	1,658	1,612	1,567	1,521	1,476	1,434	1,375	1,308	1,174
				Sones	17.5	17.2	16.8	16.5	16.2	15.8	15.8	15.9	15.9	15.4



- Greenheck Fan Corporation certifies that the model shown herein is licensed to bear the AMCA Seal. The ratings shown are based on tests and procedures performed in accordance with AMCA Publication 211 and AMCA Publication 311 and comply with the requirements of the AMCA Certified Ratings Program.
- Performance certified is for installation type B: Free inlet, Ducted outlet.
- Power rating (BHP/kW) includes transmission losses.
- Performance ratings do not include the effects of appurtenances (accessories).
- The inlet sound ratings shown are loudness values in fan sones at 5 ft. (1.5 m) in a hemispherical free field calculated per AMCA Standard 301. Values shown are for installation type B: free inlet hemispherical sone levels.