



SKU
GB-141-7X-QD-DR2

Job Name:
Mark:
Submitted By:
Date: 11/20/2019

Centrifugal Downblast Exhaust Fan, Model GB-141, Belt Drive, 3/4HP, 115/208-230V, 1Ph, Motor & Drives Unassembled, 1609-2931 CFM



Model GB, belt drive centrifugal roof exhaust fans are designed to meet the general clean air exhaust requirements for industrial and commercial buildings. Units feature a fully rolled windband bead for increased stability and easy transport. Fresh outside air is drawn in under the motor cover to maximize motor life.

- Centrifugal wheel provides high-efficiency and minimal sound
- True vibration isolation supports the motor and wheel for long life and quiet operation
- One-piece aluminum curb cap provides a weather-tight fit
- Positive motor cooling with fresh air results in maximum motor life
- Galvanized birdscreen protects the fan discharge from birds and small objects
- Motor, pulleys and belt ship separately for field assembly

Certifications

AMCA Sound & Air
High Wind and Hurricane
Seismic
UL/cUL 705

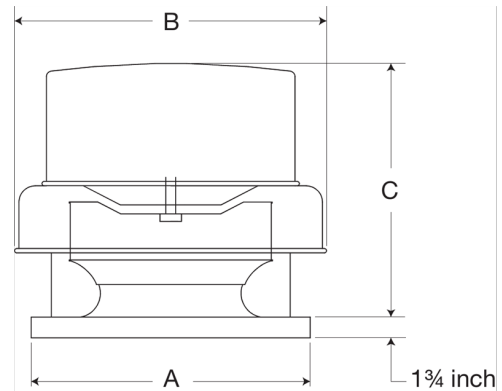

A	B	C
22 in	28.375 in	23.75 in

Performance Characteristics

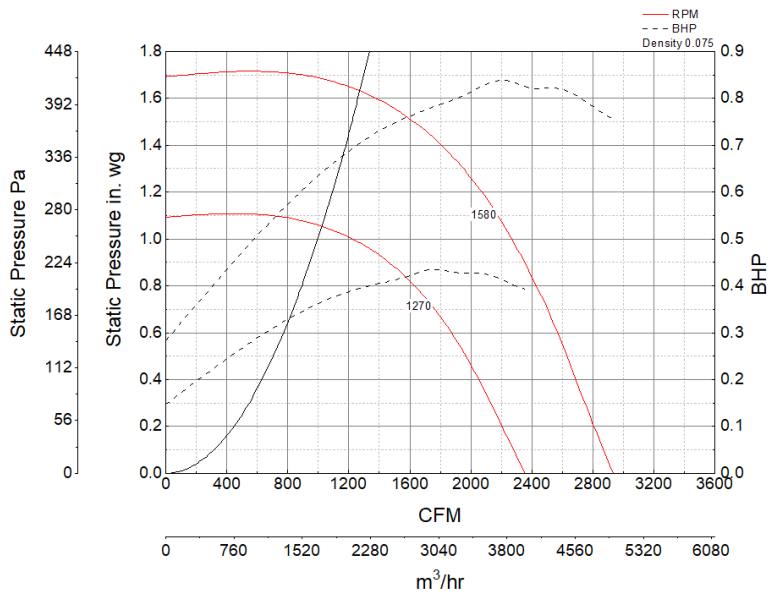

Construction Features

Drive Type	Belt Drive
Impeller Type	Centrifugal Wheel
Impeller Material	Aluminum
Housing Material	Spun Aluminum
Includes	Disconnect switch Unassembled drive package
Max Inlet Temp	180 °F
Certifications	AMCA Sound & Air High Wind and Hurricane Seismic UL/cUL 705
Drive Package Description	Motor and drives shipped loose
Required Accessory	Roof curb for new installations

Motor Information

Service Factor	1.25
Phase	1
Voltage	115 208 230
HP	3/4
Hertz	60
Motor Enclosure	Open Drip Proof
RPM	1800
Motor Insulation	B
Thermal Protection	Auto
Nominal Efficiency	70.1
NEMA Frame Size	56

Air and Sound Performance

Motor HP	Max BHP	Max Fan RPM	Min Fan RPM	Ps (in. wg)	0	0.125	0.25	0.375	0.5	0.625	0.75	0.875	1	1.25	1.5
3/4	0.83	1580	1270	CFM	2,931	2,854	2,778	2,704	2,628	2,550	2,463	2,372	2,268	2,009	1,609
				Sones	18.3	18.6	17.7	17.5	17.3	16.6	15.7	15.3	15.2	15.1	15.1



- Greenheck Fan Corporation certifies that the model shown herein is licensed to bear the AMCA Seal. The ratings shown are based on tests and procedures performed in accordance with AMCA Publication 211 and AMCA Publication 311 and comply with the requirements of the AMCA Certified Ratings Program.
- Performance certified is for installation type A: Free inlet, Free outlet.
- Power rating (BHP/kW) includes transmission losses.
- Performance ratings include the effects of birdscreen.
- The sound ratings shown are loudness values in fan sones at 5 ft. (1.5 m) in a hemispherical free field calculated per AMCA Standard 301. Values shown are for installation type A: free inlet hemispherical sone levels.