



SKU
WD100-10X10

Job Name:
Mark:
Submitted By:
Date: 09/20/2020

Backdraft damper, horizontal mount, Model WD-100, 10 In Sq, No Flange, Performance up to 2,500 ft/min



The WD-100 series are horizontally mounted backdraft dampers designed to allow vertical airflow up and prevent reverse airflow. The dampers are opened by air pressure differential (assisted by springs) and closed by gravity. The damper features a flangeless, galvanized steel frame and aluminum blades.

- Width and height furnished approximately 0.125 in. under size

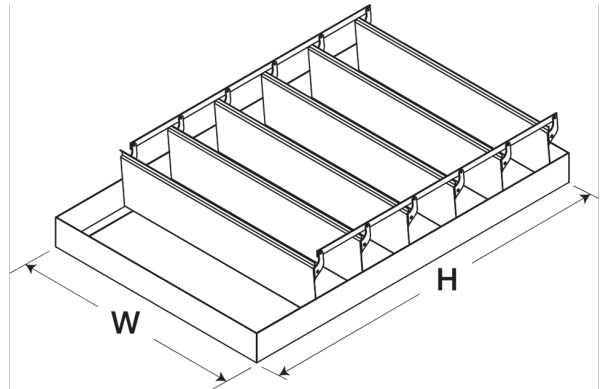

H	W
9.875 in	9.875 in

Performance Characteristics

No Fan Curve Available.

Construction Features

Frame Material	Galvanized Steel
Frame Gauge	18
Frame Type	No Flange
Blade Material	Aluminum
Blade Gauge	0.025

California Residents

⚠ WARNING

This product can expose you to chemicals including cadmium used in the processing of corrosion resistant metal and fasteners, which is known to the State of California to cause cancer and birth defects or other reproductive harm. For more information visit www.P65Warnings.ca.gov