

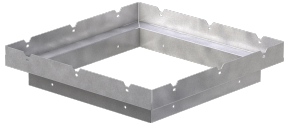

SKU
REDUCER-30-26

Job Name:
Mark:
Submitted By:
Date: 09/29/2020

Roof Curb Adapter, Reduces 30" Fan Curb Cap/Base to 26" Roof Curb



Curb adapters are designed to adapt standard curb cap dimensions to existing curb when replacing a fan or ventilator. Constructed of galvanized steel. This reducer is for use with model CUBE, sizes 180 through 200, model CUE, sizes 180 through 200, model G, sizes 183 through 203, and model GB, sizes 180 through 200.

- Reduces mounting area of fan base to fit smaller curb
- Adapt your existing curb to a new rooftop unit
- Allows for quick and easy replacements
- Galvanized steel construction

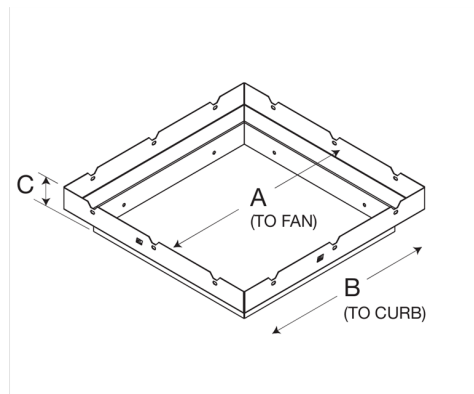

A	B	C
30 in	26 in	5 in

Performance Characteristics

No Fan Curve Available.

California Residents

 **WARNING**

This product can expose you to chemicals including cadmium used in the processing of corrosion resistant metal and fasteners, which is known to the State of California to cause cancer and birth defects or other reproductive harm. For more information visit www.P65Warnings.ca.gov