

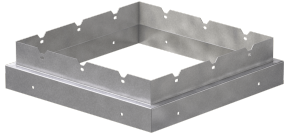

SKU
ADAPTER-17-22

Job Name:
Mark:
Submitted By:
Date: 01/19/2021

Roof Curb Adapter, Adapts 17" Fan Curb Cap/Base to 22" Roof Curb



Curb adapters are designed to adapt standard curb cap dimensions to existing curb when replacing a fan or ventilator. Constructed of galvanized steel. For use with CUE models, sizes 060 through 070, and G models, sizes 060 through 095.

- Increases mounting area of fan base to fit larger curb
- Adapt your existing curb to a new rooftop unit
- Allows for quick and easy replacements
- Galvanized steel construction

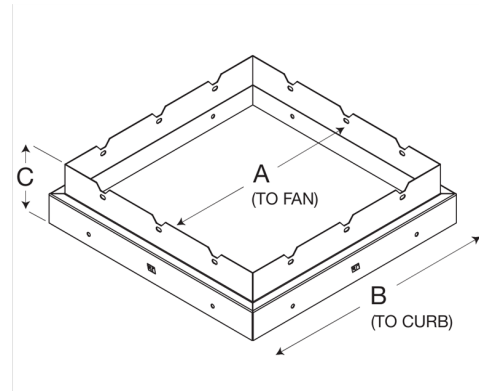

A	B	C
17 in	22 in	5 in

Performance Characteristics

No Fan Curve Available.

California Residents

 **WARNING**

This product can expose you to chemicals including cadmium used in the processing of corrosion resistant metal and fasteners, which is known to the State of California to cause cancer and birth defects or other reproductive harm. For more information visit www.P65Warnings.ca.gov